



R18

ONLY FOR ADULT

優等生、失格

優

等

生

失

格

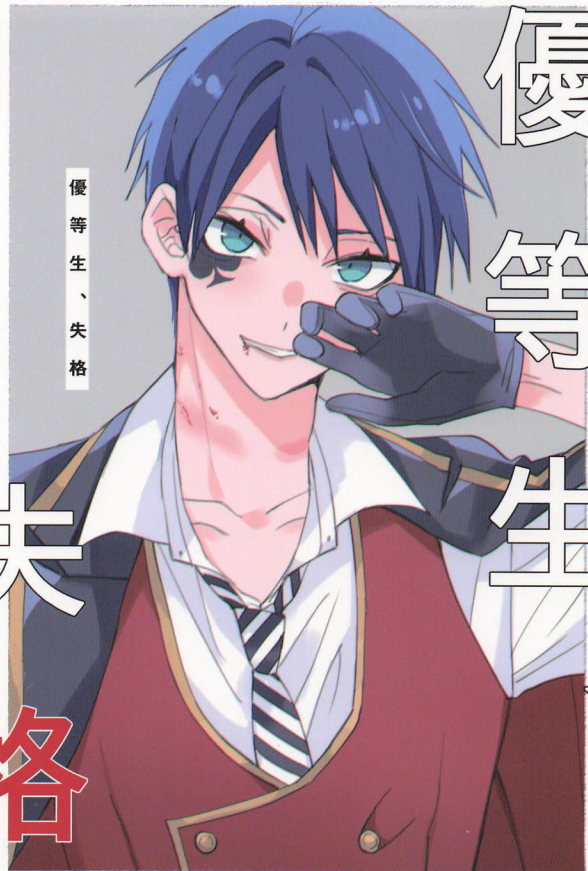

Ace is drugged with an aphrodisiac by someone.  
Then he masturbates while thinking of Deuce,  
who sees him. Rather than backing down, Deuce takes action...

[Ace x Deuce]

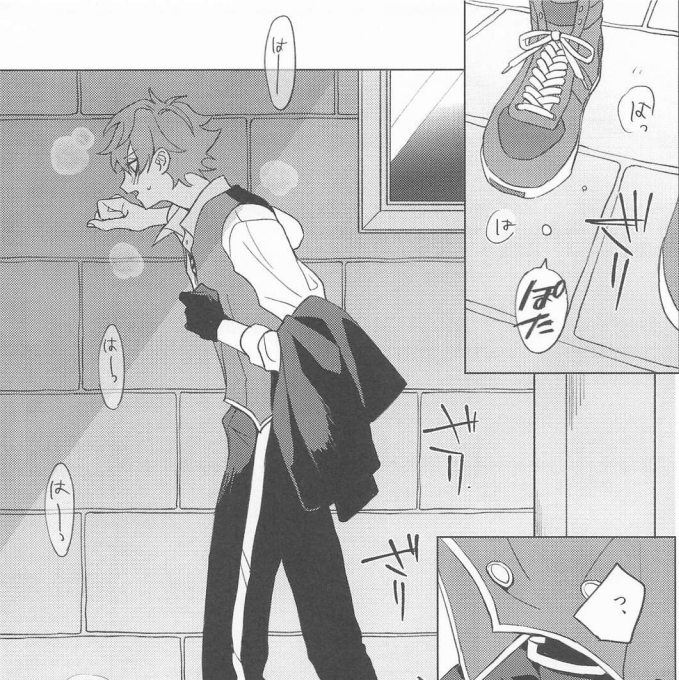

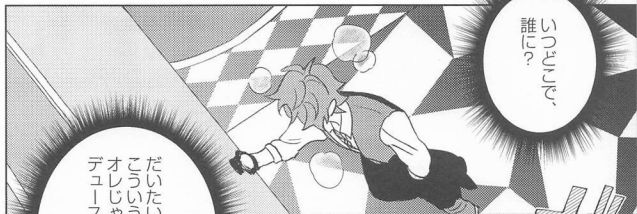

「さっさと誰に？」

「だいたい  
こういう目にあうの、  
オレじゃなくて  
デューズの担当だろ」



「はーっ」

「はーっ」



「とりあえず  
抜かねーと…」

「せせ」

「カキキ」

「カキキ」



「デューズ…」



くちゅっ

エリス…

デユースとついこの前  
付き合うことになって



ほ

ほ

エリス

まだエッチなことは  
したことないけど

そのうち  
こんなふうに  
オレのを啜えて



あ

エリス…

くちゅっ…

エリス、



くちゅっ



くちゅっ

それから、







痴態見られた

よりもよって  
恋人をオカズに  
オナってる  
くそダセーとこ

終わった

デュース…

でももう  
大丈夫だ

エース…  
その、

それ、辛いだろ

あーつらいよ  
つらすぎ

ほんと  
サイア

だよな、

?!



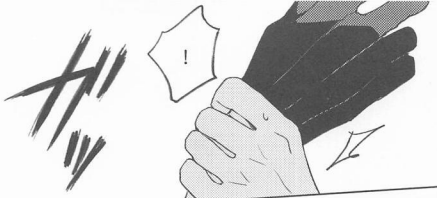

でもまあこいつが  
ホンモノじゃないなら…



好きにして  
いーよな？



エース…？!



おき！  
かき  
かき

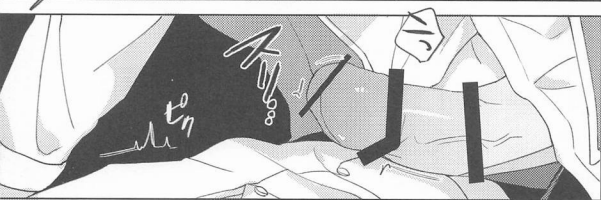





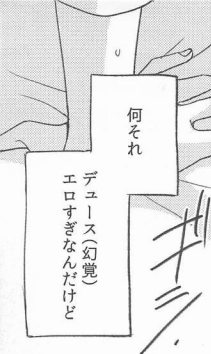

デユース(幻覚)  
エロすぎんだけど

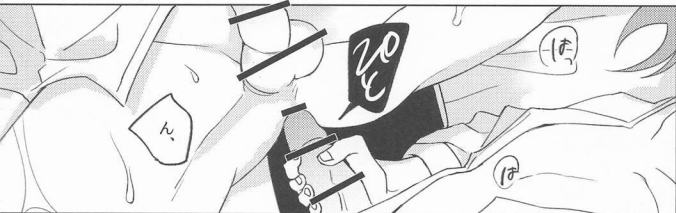







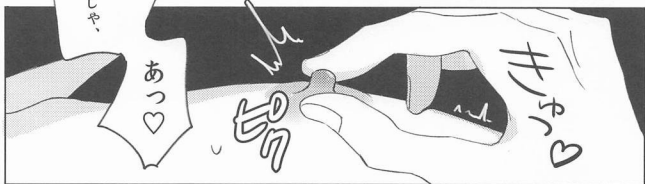



くそ…!

オレの頭ん中のデューズ  
どうなってるの??  
童貞思考かよ



エース?



あっ?!

は

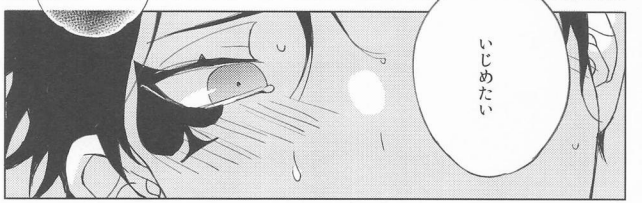



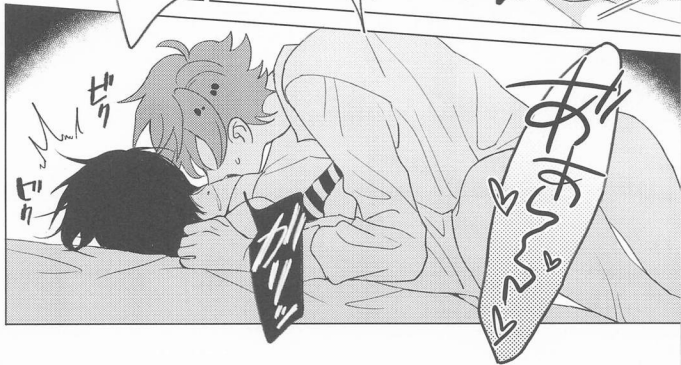











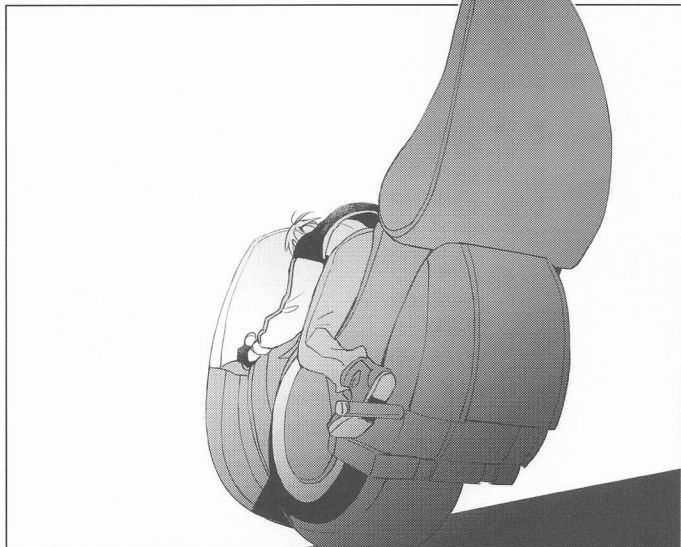
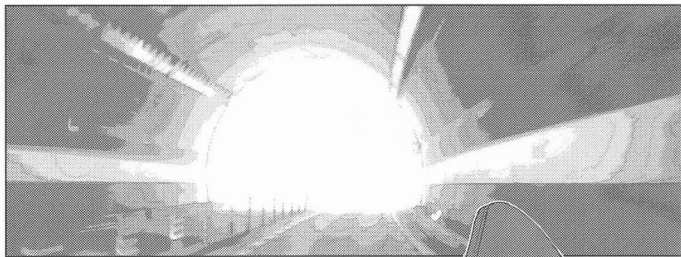







セックスって  
さいっこうだな！



?!

あっぱは!!

正気に戻った  
オレは気づいた

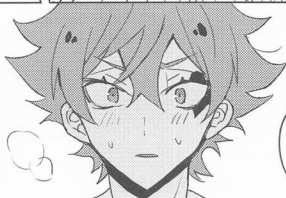

マジホイで  
峠攻めた時と同じ…、  
昔先輩が  
言ってた通りだ！



頭まっしろんって  
すげー気持ちよかったぞ！

こいつ幻覚じゃない  
本物のデューズだ

あのさ

もしかして媚薬盛ったのお前？

…モストロラウンジのポイント、ちょうど貯まってたから引き換えてもらったんだ。



エースも気持ちよかっただろ？

お前一生かかっても優等生なんかなれないよ…

えっ?! 媚薬ってハートの女王の法律で禁止されてるのか?!

END.

2024.06.30

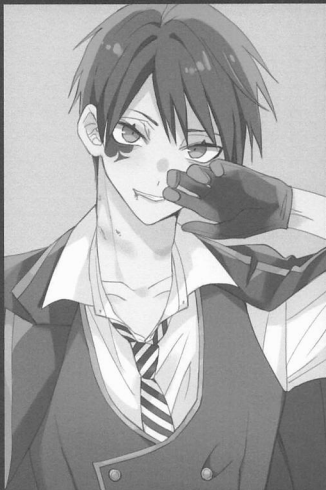

ご手紙 お読みいただき  
ありがとうございまして!!

フナナシヤットのハリストを  
峠攻めの感覚にして語る  
デューン見てこれでもう  
酸欠被虐セックス好きだぞ!!  
と確信しました。

まちがいないとトンネル内で  
絶頂してますよね^^

女はカワイイってなエステ  
がまたいじろ (カワイイってとは?)  
それでは♡

マシマロ



2024.06.30 恋はイカサマ愛は直球 JB2024  
らい宙(でんば糖)  
pixiv: 2829194  
twitter:@rose\_dechu  
mail:pika.denden113@gmail.com  
print: トム出版様

優等生、失格

2024.06.30 JUNE BRIDE Fes.2024

Presented by:DENPATOU